

THIS SHEET INCLUDES FITTING INSTRUCTIONS FOR THE FOLLOWING PARTS:

Secondary Alternator Cover Part No. EC-MT07-2014-1-GBR / Secondary Clutch Cover Part No. EC-MT07-2014-2-GBR /
 Secondary Water Pump Cover Part No. EC-MT07-2014-5-GBR / Paddock Stand Bobbin Set Part No. BA12-6-GBR-SET (MT-07 Tracer &
 Ténéré 700 models only) / Secondary Water Pipe Cover Part No. WPC-MT07-2014 /
 Bullet Frame Sliders - Street - Part No. FS-MT07-2014-LHS-S, FS-MT07-2014-RHS-S (MT-07, XSR700, FZ-07 2014-2023 & MT-07 Tracer only)
 Fixed Frame Mount Assembly Part No. FM8-GP-SET60 (Ténéré 700 model only)

SECONDARY ALTERNATOR COVER – PART NO. EC-MT07-2014-1-GBR

1. Place your bike in an upright position when fitting the Alternator as you will lose a small amount of engine oil when you remove Bolt 3.
2. Remove 4 existing bolts from the stock Alternator cover, shown as position Bolt 1, 2, 3 & 4.
2. Place the Secondary Alternator Cover over the stock cover.
3. Assemble 4 replacement **M6X50A2** bolts loosely in the correct position as shown.
4. Tighten bolts to a Torque of 10Nm as per Manufacturer's recommendations. **DO NOT OVERTIGHTEN.**

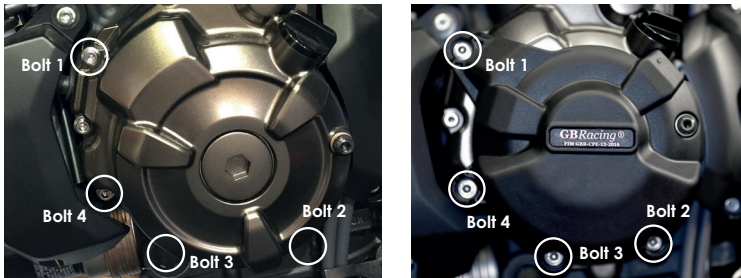

Bolt 1
M6X50A2 - 10Nm

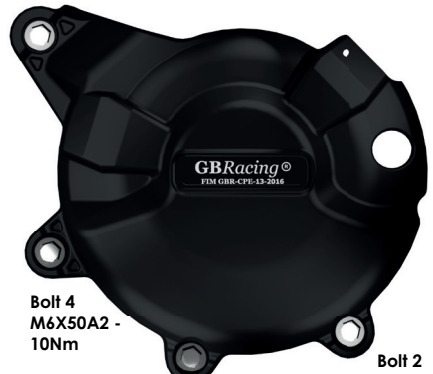

Bolt 4
M6X50A2 - 10Nm

Bolt 3
M6X50A2 - 10Nm

Bolt 2
M6X50A2 - 10Nm

TENERE 700 WORLD RAID - PLEASE NOTE!

When fitting this Alternator Cover you will need to trim the inner edge of your fairing to enable fitment, or Dremmel away the front section where needed.



SECONDARY CLUTCH COVER
PART NO. EC-MT07-2014-2-GBR

Please note: When fitting to the Yamaha Ténéré 700, please remove the small OE plastic cover before fitment.

1. Remove 4 existing bolts from the stock Clutch cover, shown as position Bolt 1, 2, 3 & 4.
2. Place the Secondary Clutch Cover over the stock cover.
3. Assemble 4 replacement bolts loosely in the correct positions as shown.
4. Tighten bolts to a Torque of 10Nm as per Manufacturer's recommendations. **DO NOT OVERTIGHTEN.**

Bolt 1
M6X35A2 - 10Nm



Bolt 2
M6X35A2 - 10Nm

Bolt 4
M6X35A2 - 10Nm

Bolt 3
M6X35A2 - 10Nm

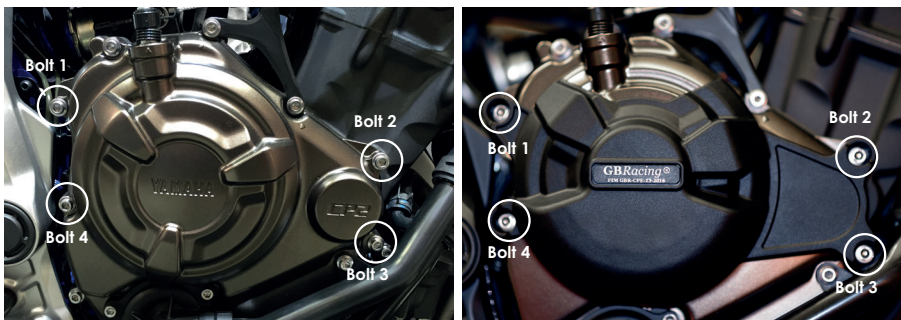

SECONDARY WATER PUMP COVER – PART NO. EC-MT07-2014-5-GBR

Please note:

- Always fit with a cold engine.
 - Coolant may leak whilst fitting the protective cover, so prepare with a container underneath the bike.
1. Remove 3 existing bolts from the stock water pump cover, shown as position Bolt 1, 2 & 3.
 2. Place the Secondary water pump cover over the stock cover.
 3. Assemble 3 replacement **M6X25A2** bolts loosely in the correct position as shown.
 4. Tighten bolts to a Torque of 10Nm as per Manufacturer's recommendations.
DO NOT OVERTIGHTEN.
 5. Check coolant levels.

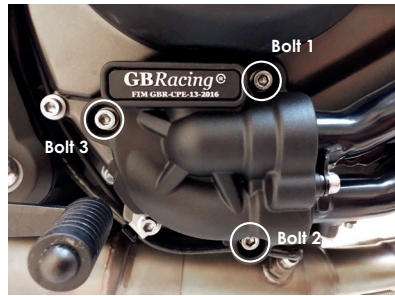
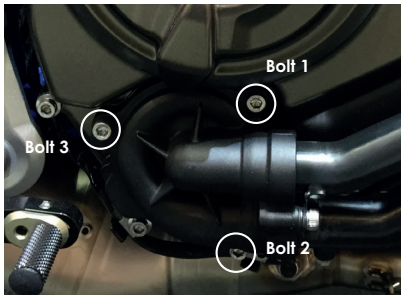
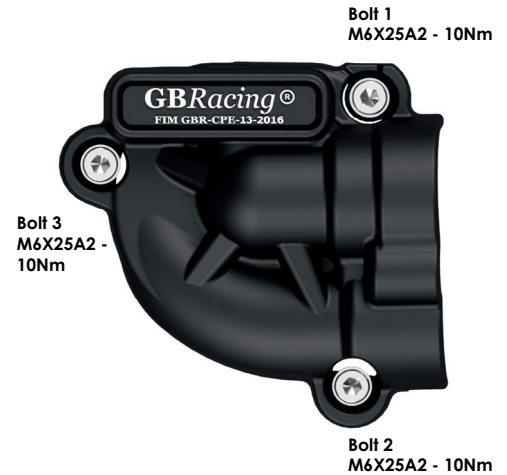

WATER PIPE COVER – PART NO. WPC-MT07-2014

1. Ensure engine is cold.
2. Remove 3 existing bolts from the correct locations.
3. Place the water pipe cover over the water pipes.
4. Assemble 3 replacement bolts from the stock water pipe cover, shown as position Bolt 1, 2 & 3.
5. Tighten bolts to a Torque of 10Nm as per Manufacturer's recommendations. DO NOT OVERTIGHTEN.

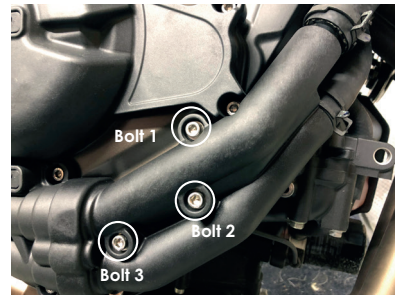
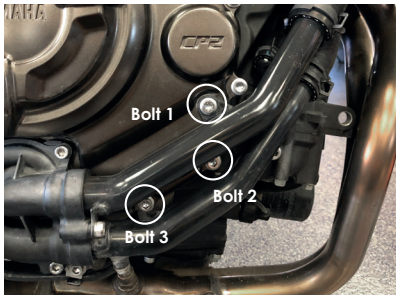

FIT MT-07, XSR700, FZ-07 2014-2024 & MT-07 TRACER ONLY:

BULLET FRAME SLIDER - LEFT HAND SIDE - STREET
 PART NO. FS-MT07-2014-LHS-S



BULLET FRAME SLIDER - RIGHT HAND SIDE - STREET
 PART NO. FS-MT07-2014-RHS-S

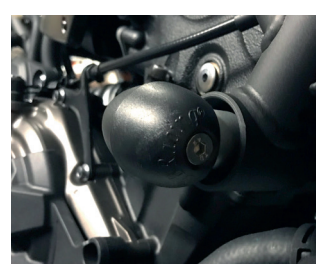

INSTRUCTIONS FOR THESE PARTS:

1. Remove upper engine mounting bolt.
2. Assemble bolt through the aluminium bush into correct position.
3. Tighten to 60NM torque.
4. Slide bullet moulding onto aluminium bush.
5. Screw M6 bolt into front of bullet moulding hand tight.

**FIXED MOUNT ASSEMBLY FOR GoPro™ CAMERA –
 PART NO. FM8-GP-SET60**

THIS PART FITS TÉNÉRÉ 700 MODEL ONLY:

- 1 Remove lower OEM M8x23 black steel bolt from position 1- [see Fig.1](#)
- 2 Add the replacement M8X30 bolt into the CPB-8-60 black anodised aluminium bush - [see Fig.2](#), and tighten up with 'Thread Lock' against position 1. Torque to 34Nm.
- 3 Place the CPM-3-GP over the bush - see Fig.3, and fix with M6X10A2CSK screw.
- 4 Fix your Go Pro to the CPM-3-GP.

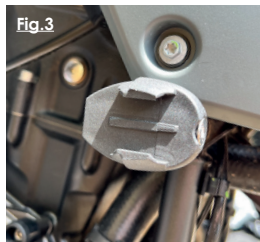
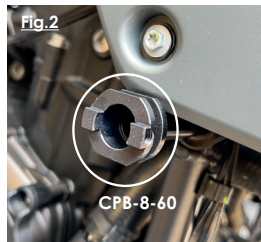
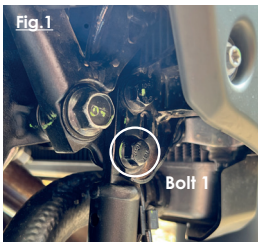

PADDOCK STAND / BOBBIN SET - PART NO. BA12-6-GBR-SET

THIS PART FITS MT-07 TRACER & TÉNÉRÉ 700 MODELS ONLY:

- 1 Assemble M6 x 40mm Bolt & M6 Washer through the moulded bobbin.
- 2 Tighten bolts to swing arm boss, 8 Nm.
DO NOT OVERTIGHTEN

